



珠海光唯电子有限公司
ZHUHAI GUANGWELL ELECTRONICS CO.,LTD

中山市拓智科技有限公司
ZHONGSHAN TUOZHI TECHNOLOGY CO.,LTD



公司简介

PROFILE

珠海光唯电子有限公司成立于2016年，是一家专业从事LED驱动电源研发与生产的厂家；企业发展至今，已成为集研发、制造、销售及服务于一体的高新技术企业。目前，公司共有员工60余名，LED开关电源的年产量近180万台，用户遍布全国，并远销到全球各地。

因公司业务不断发展扩大，为了给客户提供更好的产品及高质量服务，2020年成立中山子公司：中山市拓智科技有限公司。

目前，公司产品已通过UL、CUL、CB、UKCA、FCC、CE、RoHS、SAA、CCC、IP67和C-Tick等多项认证检测，广泛应用于全球多个国家及地区的户外景观亮化照明工程、室内家居照明、广告标识标牌等各项领域。

在企业发展过程中，光唯人始终坚持“以客户为中心，以质量为本”的发展原则，按照ISO9001国际质量体系标准生产，实现对产品质量的全方位监控，以实现我们对客户的承诺：提供品质优良、技术先进的产品及满意的服务。

ZHUHAI GUANGWELL ELECTRONICS CO.,LTD was established in 2016 ,specializing in LED Power Supply development and manufacturering.Up to now,we totally have 60 staffs,We annual supply more 1.8Millions products which are widely accepted by domestic users and export to overseas market.We have awarded High-Tech Certificate for our strong Developing,Manufacturing,Marketing and after sale services.

As company business scale keeps expanding, to offer higher quality products and better service for customers, our subsidiary company Zhongshan Tuozhi Technology Co., Ltd. was founded in 2020

Our products have passed UL,CUL,CB,UKCA,FCC,CE,RoHS,SAA,CCC,IP67andC-Tick and other tests.They apply to outdoor landscape lighting,indoor home lighting,advertising signage and other lighting solutions.

All the way along our company development, we always adhere to the principle"Take the customer as the center,take the quality as the foundation",strictly carry out the requirement of ISO9001 international quality system standards,keep on improving our quality requirements,to achieve our promise:create the products with excellent Quality,advanced technology and satisfied services to meet all customers'various requirement.



SELV

欧规超薄驱动电源 TUV CE Ultra-thin Indoor LED Power Supply	03-04
国标内置继电器驱动电源 CCC built-in LED Power Supply	05-08
美规超薄驱动电源 UL Ultra-thin LED Power Supply	09-10
ETL超薄驱动电源 ETL Ultra-thin LED Power Supply	11-14
户外欧规防水驱动电源 CE RoHS Outdoor Waterproof LED Power Supply	15-20
户外澳规防水驱动电源 SAA Outdoor Waterproof LED Power Supply	21-22
ETL防水驱动电源 ETL Waterproof LED Power Supply	23-26
室内超薄铝壳驱动电源 Indoor Ultra-Thin Aluminium LED Power Supply	27-28
室内胶壳驱动电源 Indoor Plastic LED Power Supply	29-30
内置继电器驱动电源 Indoor Built-in Relay LED Power Supply	31-32
电子开关 Electronic Switch	33-36
经济款超薄灯箱电源 Economical ultra-thin light box power supply	37-38
智能镜防雾膜 Mirror Defogger	39-40
智能镜电器装饰盒 LED mirror Decoration Box	41-42
12V/24V灯带 12V/24V LED Strip	43-44

资质证书 | QUALIFICATION CERTIFICATE



欧规超薄驱动电源

TUV CE Ultra-thin Indoor LED Power Supply

产品特点 Product Features

- ◆ 恒压设计 Constant voltage design
- ◆ 内设短路/过压过载/过热保护 Short circuit/overload/over temperature protect
- ◆ 100%满负载测试 100% full load burn-in test
- ◆ 2级保护 Class II protection
- ◆ 符合IP20防护等级 Comply with IP20 Rate
- ◆ 高功率因素，无频闪 $Pf \geq 0.9$ No Flicker design





15W/24W IP20 TUV CE Led Power Supply
欧规超薄电源



型号 Model No.	功率 Power	输入电压 Input Voltage	输出电压 Output Voltage	输出电流 Output Current	效率 Efficiency	重量 N.W	防护等级 IP	尺寸 Size(MM)
GW-1512CV	15W	AC170-265V	12V	0~1.25A	85%	120g	IP20	128*50*15
GW-1524CV	15W	AC170-265V	24V	0~0.625A	85%	120g	IP20	128*50*15
GW-2412CV	24W	AC170-265V	12V	0~2A	85%	120g	IP20	128*50*15
GW-2424CV	24W	AC170-265V	24V	0~1A	85%	120g	IP20	128*50*15



36W IP20 TUV CE Led Power Supply
欧规超薄电源



型号 Model No.	功率 Power	输入电压 Input Voltage	输出电压 Output Voltage	输出电流 Output Current	效率 Efficiency	重量 N.W	防护等级 IP	尺寸 Size(MM)
GW-3612CV	36W	AC170-265V	12V	0~3A	85%	130g	IP20	128*50*15
GW-3624CV	36W	AC170-265V	24V	0~1.5A	85%	130g	IP20	128*50*15



48W/60W IP20 TUV CE Led Power Supply
欧规超薄电源



型号 Model No.	功率 Power	输入电压 Input Voltage	输出电压 Output Voltage	输出电流 Output Current	效率 Efficiency	重量 N.W	防护等级 IP	尺寸 Size(MM)
GW-4812CV	48W	AC170-265V	12V	0~4A	85%	220g	IP20	160*58*18.5
GW-4824CV	48W	AC170-265V	24V	0~2A	85%	220g	IP20	160*58*18.5
GW-6012CV	60W	AC170-265V	12V	0~5A	85%	220g	IP20	160*58*18.5
GW-6024CV	60W	AC170-265V	24V	0~2.5A	85%	220g	IP20	160*58*18.5

国标内置继电器驱动电源

CCC built-in relay LED Power supply

产品特点 Product Features

- ◆ 恒压设计 Constant voltage Design
- ◆ 内设短路/过压过载/过热保护 Short circuit/over load/over temperature protect
- ◆ 100%满负载测试 100% full load burn-in test
- ◆ 2级保护 Class II protection
- ◆ 符合IP44防护等级 Comply with IP44 Rate
- ◆ 内置继电器设计 built-in relay design





15W Built-in relay LED Power Supply 内置继电器驱动电源



型号 Model No.	功率 Power	输入电压 Input Voltage	输出电压 Output Voltage	输出电流 Output Current	效率 Efficiency	防护等级 IP	尺寸 Size(MM)
TZ-1512C-L	15W	AC 200-240V	12V	0~1.25A	82%	IP44	125*45*14.5
TZ-1524C-L	15W	AC 200-240V	24V	0~0.625A	83%	IP44	125*45*14.5

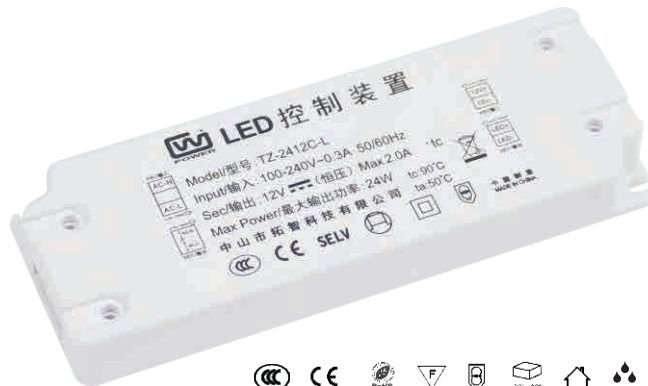

24W Built-in relay LED Power Supply 内置继电器驱动电源



型号 Model No.	功率 Power	输入电压 Input Voltage	输出电压 Output Voltage	输出电流 Output Current	效率 Efficiency	防护等级 IP	尺寸 Size(MM)
TZ-2412C-L	24W	AC 200-240V	12V	0~2A	82%	IP44	125*45*14.5
TZ-2424C-L	24W	AC 200-240V	24V	0~1A	83%	IP44	125*45*14.5



36W Built-in relay LED Power Supply 内置继电器驱动电源



型号 Model No.	功率 Power	输入电压 Input Voltage	输出电压 Output Voltage	输出电流 Output Current	效率 Efficiency	防护等级 IP	尺寸 Size(MM)
TZ-3612C-L	36W	AC 200-240V	12V	0~3A	82%	IP44	145*53*16.5
TZ-3624C-L	36W	AC 200-240V	24V	0~1.5A	83%	IP44	145*53*16.5

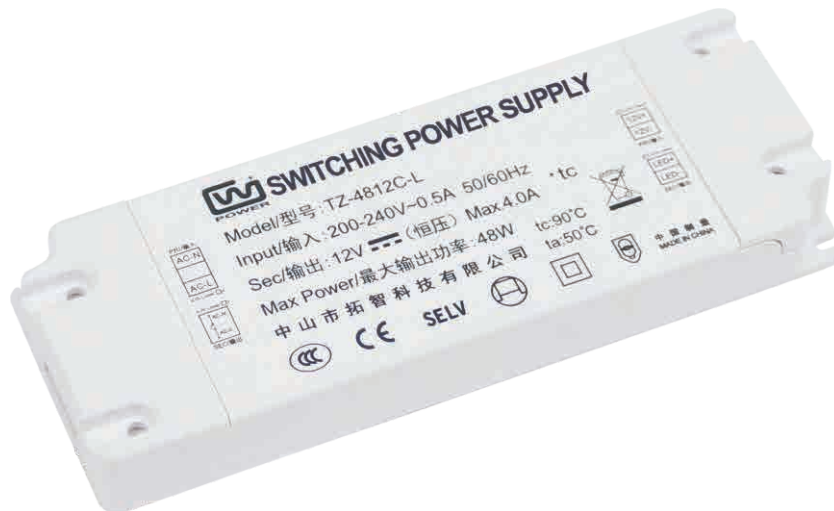

48W Built-in relay LED Power Supply
内置继电器驱动电源



型号 Model No.	功率 Power	输入电压 Input Voltage	输出电压 Output Voltage	输出电流 Output Current	效率 Efficiency	防护等级 IP	尺寸 Size(MM)
TZ-4812C-L	48W	AC 200-240V	12V	0~4A	82%	IP44	145*53*16.5
TZ-4824C-L	48W	AC 200-240V	24V	0~2A	83%	IP44	145*53*16.5



60W Built-in relay LED Power Supply
内置继电器驱动电源



型号 Model No.	功率 Power	输入电压 Input Voltage	输出电压 Output Voltage	输出电流 Output Current	效率 Efficiency	防护等级 IP	尺寸 Size(MM)
TZ-6012C-L	60W	AC 200-240V	12V	0~5A	82%	IP44	185*56*19
TZ-6024C-L	60W	AC 200-240V	24V	0~2.5A	83%	IP44	185*56*19



72W Built-in relay LED Power Supply
内置继电器驱动电源



型号 Model No.	功率 Power	输入电压 Input Voltage	输出电压 Output Voltage	输出电流 Output Current	效率 Efficiency	防护等级 IP	尺寸 Size(MM)
TZ-7212C-L	72W	AC 200-240V	12V	0~6A	82%	IP44	185*56*19
TZ-7224C-L	72W	AC 200-240V	24V	0~3A	83%	IP44	185*56*19



96W Built-in relay LED Power Supply
内置继电器驱动电源



型号 Model No.	功率 Power	输入电压 Input Voltage	输出电压 Output Voltage	输出电流 Output Current	效率 Efficiency	防护等级 IP	尺寸 Size(MM)
TZ-9612C-L	96W	AC 200-240V	12V	0~8A	82%	IP44	185*56*19
TZ-9624C-L	96W	AC 200-240V	24V	0~4A	83%	IP44	185*56*19

美规超薄驱动电源

UL Ultra-thin LED Power Supply

产品特点 Product Features

- ◆ 恒压设计 Constant voltage design
- ◆ 内设短路/过压过载/过热保护 Short circuit/overload/over temperature protect
- ◆ 100%满负载测试 100% full load burn-in test
- ◆ 2级保护 Class II protection
- ◆ 可在潮湿环境中使用 Can work in humid environment
- ◆ 符合IP44防护等级 Comply with IP44 Rate





24W/36W

IP44 UL
LED Power Supply
美规超薄电源



型号 Model No.	功率 Power	输入电压 Input Voltage	输出电压 Output Voltage	输出电流 Output Current	效率 Efficiency	重量 N.W	防护等级 IP	尺寸 Size(MM)
TZ-2412D-A	24W	AC100-240V 50/60HZ	12V	0~2A	85%	108g	IP20	136*53*18
TZ-2424D-A	24W	AC100-240V 50/60HZ	24V	0~1A	85%	108g	IP20	136*53*18
TZ-3612D-A	36W	AC100-240V 50/60HZ	12V	0~3A	85%	145g	IP44	136*53*18
TZ-3624D-A	36W	AC100-240V 50/60HZ	24V	0~1.5A	85%	145g	IP44	136*53*18



48W

IP44 UL
LED Power Supply
美规超薄电源



型号 Model No.	功率 Power	输入电压 Input Voltage	输出电压 Output Voltage	输出电流 Output Current	效率 Efficiency	重量 N.W	防护等级 IP	尺寸 Size(MM)
TZ-4812K-A	48W	AC100-277V 50/60HZ	12V	0~4A	85%	255g	IP44	205*53*18
TZ-4824K-A	48W	AC100-277V 50/60HZ	24V	0~2A	85%	255g	IP44	205*53*18



60W/75W

IP44 UL
LED Power Supply
美规超薄电源



型号 Model No.	功率 Power	输入电压 Input Voltage	输出电压 Output Voltage	输出电流 Output Current	效率 Efficiency	重量 N.W	防护等级 IP	尺寸 Size(MM)
TZ-6012K-A	60W	AC100-277V 50/60HZ	12V	0~5A	85%	255g	IP44	205*53*18
TZ-6024K-A	60W	AC100-277V 50/60HZ	24V	0~2.5A	85%	255g	IP44	205*53*18
TZ-7524K-A	75W	AC100-277V 50/60HZ	24V	0~3.13A	85%	255g	IP44	205*53*18

ETL超薄驱动电源

ETL Ultra-thin LED Power supply

产品特点 Product Features

- ◆ 恒压设计 Constant voltage Design
- ◆ 内设短路/过压过载/过热保护 Short circuit/over load/over temperature protect
- ◆ 100%满负载测试 100% full load burn-in test
- ◆ 2级保护 Class II protection
- ◆ 可在潮湿环境中使用 Can work in humid environment
- ◆ 符合IP44防护等级 Comply with IP44 Rate





15W IP44 ETL
LED Power Supply
ETL超薄电源



型号 Model No.	功率 Power	输入电压 Input Voltage	输出电压 Output Voltage	输出电流 Output Current	效率 Efficiency	防护等级 IP	尺寸 Size(MM)
TZ-1512C	15W	AC 100-240V	12V	0~1.25A	82%	IP44	125*45*14.5
TZ-1524C	15W	AC 100-240V	24V	0~0.625A	83%	IP44	125*45*14.5



24W IP44 ETL
LED Power Supply
ETL超薄电源



型号 Model No.	功率 Power	输入电压 Input Voltage	输出电压 Output Voltage	输出电流 Output Current	效率 Efficiency	防护等级 IP	尺寸 Size(MM)
TZ-2412C	24W	AC 100-240V	12V	0~2A	82%	IP44	125*45*14.5
TZ-2424C	24W	AC 100-240V	24V	0~1A	83%	IP44	125*45*14.5



36W IP44 ETL
LED Power Supply
ETL超薄电源



型号 Model No.	功率 Power	输入电压 Input Voltage	输出电压 Output Voltage	输出电流 Output Current	效率 Efficiency	防护等级 IP	尺寸 Size(MM)
TZ-3612C	36W	AC 100-240V	12V	0~3A	82%	IP44	145*53*16.5
TZ-3624C	36W	AC 100-240V	24V	0~1.5A	83%	IP44	145*53*16.5



48W IP44 ETL
LED Power Supply
ETL超薄电源



型号 Model No.	功率 Power	输入电压 Input Voltage	输出电压 Output Voltage	输出电流 Output Current	效率 Efficiency	防护等级 IP	尺寸 Size(MM)
TZ-4812C	48W	AC 100-240V	12V	0~4A	82%	IP44	145*53*16.5
TZ-4824C	48W	AC 100-240V	24V	0~2A	83%	IP44	145*53*16.5



60W IP44 ETL
LED Power Supply
ETL超薄电源



型号 Model No.	功率 Power	输入电压 Input Voltage	输出电压 Output Voltage	输出电流 Output Current	效率 Efficiency	防护等级 IP	尺寸 Size(MM)
TZ-6012C	60W	AC 100-240V	12V	0~5A	82%	IP44	185*56*19
TZ-6024C	60W	AC 100-240V	24V	0~2.5A	83%	IP44	185*56*19



72W IP44 ETL
LED Power Supply
ETL超薄电源



型号 Model No.	功率 Power	输入电压 Input Voltage	输出电压 Output Voltage	输出电流 Output Current	效率 Efficiency	防护等级 IP	尺寸 Size(MM)
TZ-7224C	72W	AC 100-240V	24V	0~3A	83%	IP44	185*56*19



96W IP44 ETL
LED Power Supply
ETL超薄电源



型号 Model No.	功率 Power	输入电压 Input Voltage	输出电压 Output Voltage	输出电流 Output Current	效率 Efficiency	防护等级 IP	尺寸 Size(MM)
TZ-9624C	96W	AC 100-240V	24V	0~4A	83%	IP44	185*56*19

户外欧规防水驱动电源

CE RoHS Outdoor Waterproof LED Power Supply

产品特点 Product Features

- ◆ 恒压设计 Constant voltage design
- ◆ 铝壳封装,符合IP67防水等级 Aluminum shell,IP67
- ◆ 内设短路/过压过载/过热保护 Short circuit/overload/over temperature protect
- ◆ 100%满负载测试 100% full load burn-in test
- ◆ 空气自然对流散热 Air natural convection colling
- ◆ CE,RoHS认证 CE,RoHS Certificate



10W IP67 Waterproof LED Power Supply
户外防水电源



CE RoHS F Tc IP67 IP67 Ta SELV

型号 Model No.	功率 Power	输入电压 Input Voltage	输出电压 Output Voltage	输出电流 Output Current	效率 Efficiency	重量 N.W	防护等级 IP	尺寸 Size(MM)
FV-1012	10W	AC100-240V	12V	0~0.83A	82%	115g	IP67	115*30*20
FV-1024	10W	AC100-240V	24V	0~0.41A	83%	115g	IP67	115*30*20

15W IP67 Waterproof LED Power Supply
户外防水电源



CE RoHS F Tc IP67 IP67 Ta SELV

型号 Model No.	功率 Power	输入电压 Input Voltage	输出电压 Output Voltage	输出电流 Output Current	效率 Efficiency	重量 N.W	防护等级 IP	尺寸 Size(MM)
FV-1512	15W	AC100-240V	12V	0~1.25A	82%	115g	IP67	115*30*20
FV-1524	15W	AC100-240V	24V	0~0.625A	83%	115g	IP67	115*30*20

20W IP67 Waterproof LED Power Supply
户外防水电源



CE RoHS F Tc IP67 IP67 Ta SELV

型号 Model No.	功率 Power	输入电压 Input Voltage	输出电压 Output Voltage	输出电流 Output Current	效率 Efficiency	重量 N.W	防护等级 IP	尺寸 Size(MM)
FV-2012	20W	AC100-240V	12V	0~1.66A	82%	155g	IP67	165*30*20
FV-2024	20W	AC100-240V	24V	0~0.83A	83%	155g	IP67	165*30*20



24W IP67 Waterproof LED Power Supply
户外防水电源



型号 Model No.	功率 Power	输入电压 Input Voltage	输出电压 Output Voltage	输出电流 Output Current	效率 Efficiency	重量 N.W	防护等级 IP	尺寸 Size(MM)
FV-2412	24W	AC100-240V	12V	0~2A	82%	155g	IP67	165*30*20
FV-2424	24W	AC100-240V	24V	0~1A	83%	155g	IP67	165*30*20



30W IP67 Waterproof LED Power Supply
户外防水电源



型号 Model No.	功率 Power	输入电压 Input Voltage	输出电压 Output Voltage	输出电流 Output Current	效率 Efficiency	重量 N.W	防护等级 IP	尺寸 Size(MM)
FV-3012	30W	AC100-240V	12V	0~2.5A	82%	187g	IP67	180*30*20
FV-3024	30W	AC100-240V	24V	0~1.25A	83%	187g	IP67	180*30*20

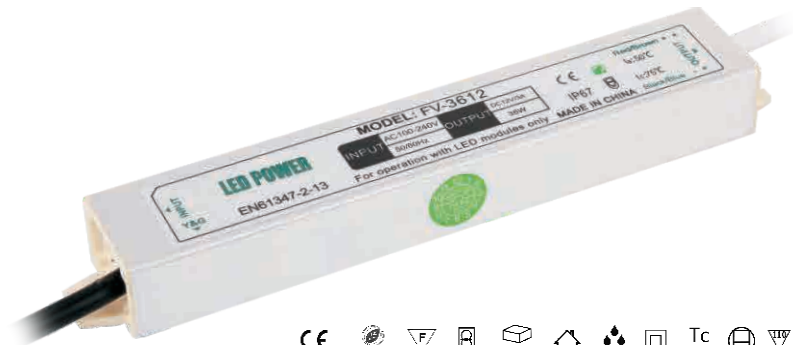

36W IP67 Waterproof LED Power Supply
户外防水电源



型号 Model No.	功率 Power	输入电压 Input Voltage	输出电压 Output Voltage	输出电流 Output Current	效率 Efficiency	重量 N.W	防护等级 IP	尺寸 Size(MM)
FV-3612	36W	AC100-240V	12V	0~3A	82%	187g	IP67	180*30*20
FV-3624	36W	AC100-240V	24V	0~1.5A	83%	187g	IP67	180*30*20



45W IP67 Waterproof LED Power Supply
户外防水电源



型号 Model No.	功率 Power	输入电压 Input Voltage	输出电压 Output Voltage	输出电流 Output Current	效率 Efficiency	重量 N.W	防护等级 IP	尺寸 Size(MM)
FV-4512	45W	AC100-240V	12V	0~3.75A	82%	228g	IP67	220*30*20
FV-4524	45W	AC100-240V	24V	0~1.875A	83%	228g	IP67	220*30*20



60W IP67 Waterproof LED Power Supply
户外防水电源



型号 Model No.	功率 Power	输入电压 Input Voltage	输出电压 Output Voltage	输出电流 Output Current	效率 Efficiency	重量 N.W	防护等级 IP	尺寸 Size(MM)
FV-6012	60W	AC100-240V	12V	0~5A	82%	330g	IP67	220*40*22
FV-6024	60W	AC100-240V	24V	0~2.5A	83%	330g	IP67	220*40*22



72W IP67 Waterproof LED Power Supply
户外防水电源



型号 Model No.	功率 Power	输入电压 Input Voltage	输出电压 Output Voltage	输出电流 Output Current	效率 Efficiency	重量 N.W	防护等级 IP	尺寸 Size(MM)
FV-7212	72W	AC170-265V	12V	0~6A	82%	385g	IP67	260*40*22
FV-7224	72W	AC170-265V	24V	0~3A	83%	385g	IP67	260*40*22



100W IP67 Waterproof LED Power Supply
户外防水电源

CE RoHS V F -20~+30° IP67 Tc 15° W W Ta -10~+45° SELV

型号 Model No.	功率 Power	输入电压 Input Voltage	输出电压 Output Voltage	输出电流 Output Current	效率 Efficiency	重量 N.W	防护等级 IP	尺寸 Size(MM)
FV-10012	100W	AC100-240V	12V	0~8.33A	86%	450g	IP67	210*42*30
FV-10024	100W	AC100-240V	24V	0~4.2A	87%	450g	IP67	210*42*30



150W IP67 Waterproof LED Power Supply
户外防水电源

CE RoHS V F -20~+30° IP67 Tc 15° W W Ta -10~+45° SELV

型号 Model No.	功率 Power	输入电压 Input Voltage	输出电压 Output Voltage	输出电流 Output Current	效率 Efficiency	重量 N.W	防护等级 IP	尺寸 Size(MM)
FV-15012	150W	AC100-240V	12V	0~12.5A	88%	615g	IP67	280*42*30
FV-15024	150W	AC100-240V	24V	0~6.25A	89%	615g	IP67	280*42*30



200W IP67 Waterproof LED Power Supply
户外防水电源

CE RoHS V F -20~+30° IP67 Tc 15° W W Ta -10~+45° SELV

型号 Model No.	功率 Power	输入电压 Input Voltage	输出电压 Output Voltage	输出电流 Output Current	效率 Efficiency	重量 N.W	防护等级 IP	尺寸 Size(MM)
FV-20012	200W	AC100-240V	12V	0~16.7A	88%	1210g	IP67	264*80*31
FV-20024	200W	AC100-240V	24V	0~8.3A	89%	1210g	IP67	264*80*31



300W

IP67 Waterproof
LED Power Supply
户外防水电源



型号 Model No.	功率 Power	输入电压 Input Voltage	输出电压 Output Voltage	输出电流 Output Current	效率 Efficiency	重量 N.W	防护等级 IP	尺寸 Size(MM)
FV-30012	300W	AC100-240V	12V	0~33A	88%	1400g	IP67	294*80*31
FV-30024	300W	AC100-240V	24V	0~16.7A	89%	1760g	IP67	294*70*49



400W

IP67 Waterproof
LED Power Supply
户外防水电源



型号 Model No.	功率 Power	输入电压 Input Voltage	输出电压 Output Voltage	输出电流 Output Current	效率 Efficiency	重量 N.W	防护等级 IP	尺寸 Size(MM)
FV-40012	400W	AC100-240V	12V	0~33A	88%	1400g	IP67	294*80*31
FV-40024	400W	AC100-240V	24V	0~16.7A	89%	1760g	IP67	294*70*49

户外澳规防水驱动电源

SAA Outdoor Waterproof LED Power Supply

产品特点 Product Features

- ◆ 恒压设计 Constant voltage design
- ◆ 铝壳封装,符合IP67防水等级 Aluminum shell,IP67
- ◆ 内设短路/过压过载/过热保护 Short circuit/overload/over temperature protect
- ◆ 100%满负载测试 100% full load burn-in test
- ◆ 空气自然对流散热 Air natural convection colling
- ◆ CE ,SAA认证 CE,SAA, Certificate

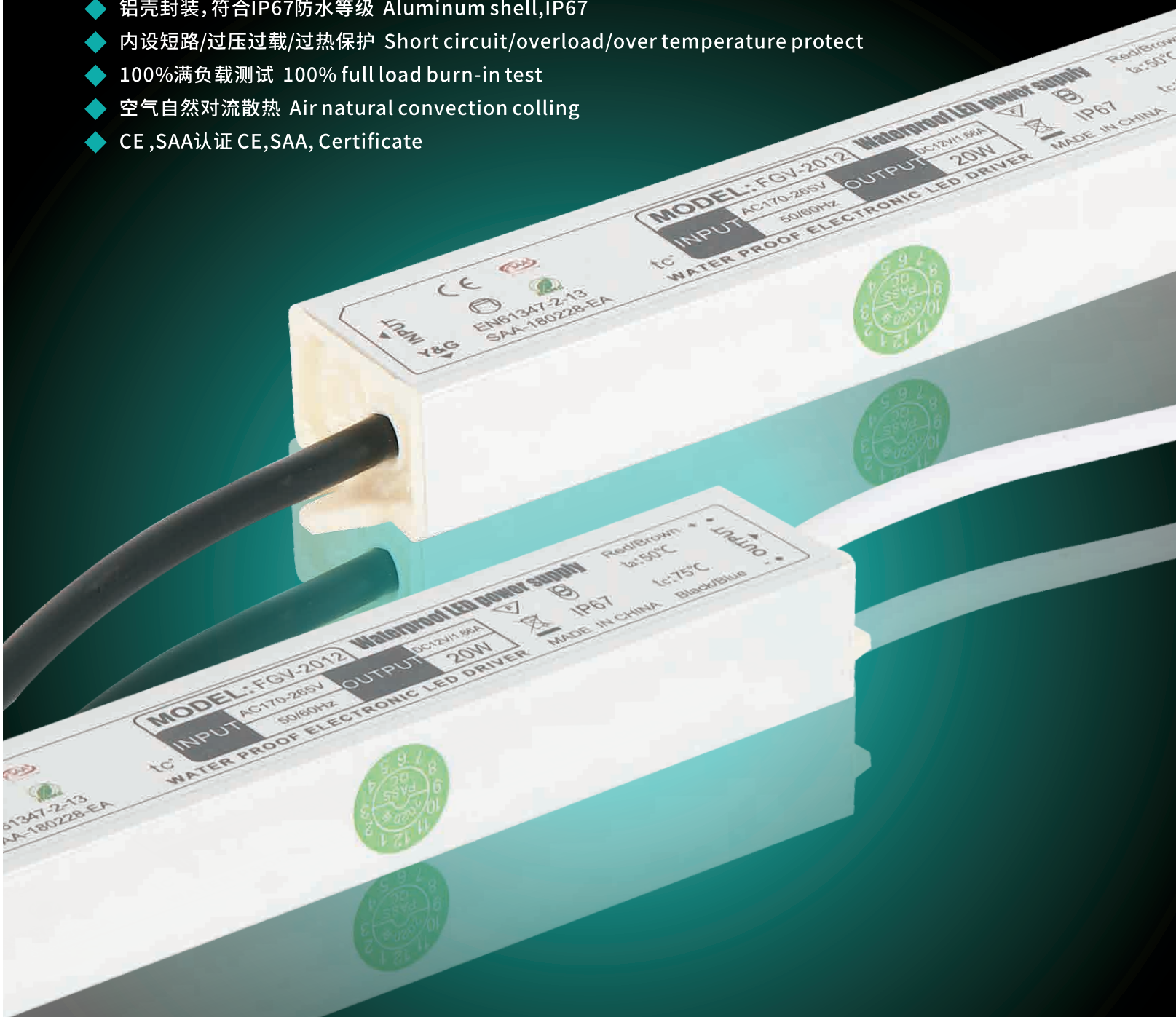



20W/30W

IP67 waterproof
LED Power Supply
户外防水电源



型号 Model No.	功率 Power	输入电压 Input Voltage	输出电压 Output Voltage	输出电流 Output Current	效率 Efficiency	重量 N.W	防护等级 IP	尺寸 Size(MM)
FGV-2012	20W	AC170-265V	12V	0~1.66A	82%	155g	IP67	165*30*20
FGV-2024	20W	AC170-265V	24V	0~0.83A	83%	155g	IP67	165*30*20
FGV-3012	30W	AC170-265V	12V	0~2.5A	82%	187g	IP67	180*30*20
FGV-3024	30W	AC170-265V	24V	0~1.25A	83%	187g	IP67	180*30*20



45W

IP67 waterproof
LED Power Supply
户外防水电源



型号 Model No.	功率 Power	输入电压 Input Voltage	输出电压 Output Voltage	输出电流 Output Current	效率 Efficiency	重量 N.W	防护等级 IP	尺寸 Size(MM)
FGV-4512	45W	AC170-265V	12V	0~3.75A	82%	330g	IP67	200*40*22
FGV-4524	45W	AC170-265V	24V	0~1.875A	83%	330g	IP67	200*40*22

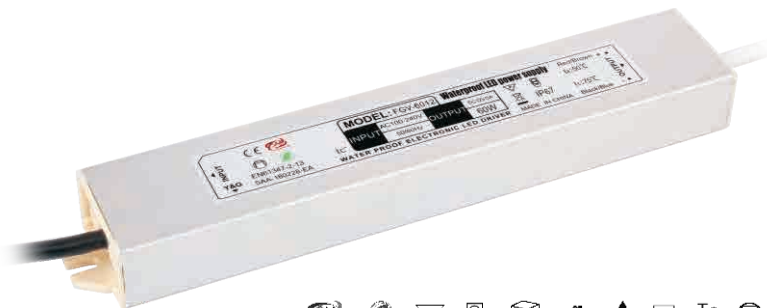

60W

IP67 waterproof
LED Power Supply
户外防水电源



型号 Model No.	功率 Power	输入电压 Input Voltage	输出电压 Output Voltage	输出电流 Output Current	效率 Efficiency	重量 N.W	防护等级 IP	尺寸 Size(MM)
FGV-6012	60W	AC170-265V	12V	0~5A	82%	330g	IP67	220*40*22
FGV-6024	60W	AC170-265V	24V	0~2.5A	83%	330g	IP67	220*40*22

ETL防水驱动电源

ETL waterproof LED Power supply

产品特点 Product Features

- ◆ 恒压设计 Constant voltage Design
- ◆ 内设短路/过压过载/过热保护 Short circuit/over load/over temperature protect
- ◆ 100%满负载测试 100% full load burn-in test
- ◆ 空气自然对流散热 Air natural convection cooling
- ◆ ETL,CE,FCC 认证 CCC,CE,FCC Certificate





15W IP67 ETL LED Power Supply ETL防水电源



型号 Model No.	功率 Power	输入电压 Input Voltage	输出电压 Output Voltage	输出电流 Output Current	效率 Efficiency	防护等级 IP	尺寸 Size(MM)
TZ-1512B	15W	AC 100-240V	12V	0~1.25A	82%	IP67	137*45*21
TZ-1524B	15W	AC 100-240V	24V	0~0.625A	83%	IP67	137*45*21



24W IP67 ETL LED Power Supply ETL防水电源



型号 Model No.	功率 Power	输入电压 Input Voltage	输出电压 Output Voltage	输出电流 Output Current	效率 Efficiency	防护等级 IP	尺寸 Size(MM)
TZ-2412B	24W	AC 100-240V	12V	0~2A	82%	IP67	137*45*21
TZ-2424B	24W	AC 100-240V	24V	0~1A	83%	IP67	137*45*21



36W IP67 ETL LED Power Supply ETL防水电源



型号 Model No.	功率 Power	输入电压 Input Voltage	输出电压 Output Voltage	输出电流 Output Current	效率 Efficiency	防护等级 IP	尺寸 Size(MM)
TZ-3612B	36W	AC 100-240V	12V	0~3A	82%	IP67	152*53*21
TZ-3624B	36W	AC 100-240V	24V	0~1.5A	83%	IP67	152*53*21



48W IP67 ETL
LED Power Supply
ETL防水电源



型号 Model No.	功率 Power	输入电压 Input Voltage	输出电压 Output Voltage	输出电流 Output Current	效率 Efficiency	防护等级 IP	尺寸 Size(MM)
TZ-4812B	48W	AC 100-240V	12V	0~4A	82%	IP67	152*53*21
TZ-4824B	48W	AC 100-240V	24V	0~2A	83%	IP67	152*53*21



60W IP67 ETL
LED Power Supply
ETL防水电源



型号 Model No.	功率 Power	输入电压 Input Voltage	输出电压 Output Voltage	输出电流 Output Current	效率 Efficiency	防护等级 IP	尺寸 Size(MM)
TZ-6012B	60W	AC 100-240V	12V	0~5A	82%	IP67	190*59*21
TZ-6024B	60W	AC 100-240V	24V	0~2.5A	83%	IP67	190*59*21



72W IP67 ETL
LED Power Supply
ETL防水电源



















型号 Model No.	功率 Power	输入电压 Input Voltage	输出电压 Output Voltage	输出电流 Output Current	效率 Efficiency	防护等级 IP	尺寸 Size(MM)
TZ-7224B	72W	AC 100-240V	24V	0~3A	83%	IP67	190*59*21



96W IP67 ETL
LED Power Supply
ETL防水电源



















型号 Model No.	功率 Power	输入电压 Input Voltage	输出电压 Output Voltage	输出电流 Output Current	效率 Efficiency	防护等级 IP	尺寸 Size(MM)
TZ-9624B	96W	AC 100-240V	24V	0~4A	83%	IP67	190*59*21

室内超薄铝壳驱动电源

Indoor Ultra-Thin Aluminium LED Power Supply

产品特点 Product Features

- ◆ 恒压设计 Constant voltage design
- ◆ 超薄设计, 适用狭窄空间 Ultra thin design, suitable for narrow space
- ◆ 内设短路/过压过载/过热保护 Short circuit/overload/over temperature protect
- ◆ 100%满负载测试 100% full load burn-in test
- ◆ 空气自然对流散热 Air natural convection colling
- ◆ 符合IP20防护等级, RoHS环保标准 Comply with IP20&RoHS standards
- ◆ CE,RoHS认证 CE,RoHS Certificate



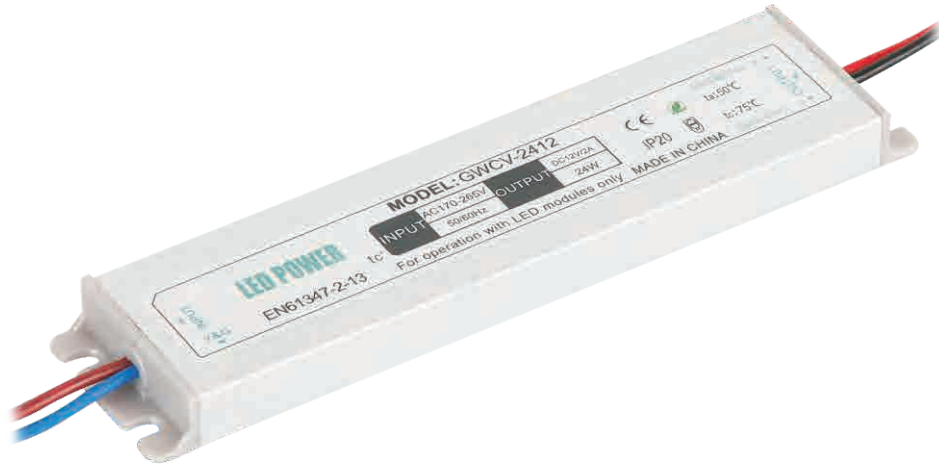

24W IP20 Indoor
Ultra-Thin Aluminium Power Supply
室内超薄铝壳电源

CE RoHS F V 20~30° 120 85° Tc 10~15° SELV

型号 Model No.	功率 Power	输入电压 Input Voltage	输出电压 Output Voltage	输出电流 Output Current	效率 Efficiency	重量 N.W	防护等级 IP	尺寸 Size(MM)
GWCV-2412	24W	AC170-265V	12V	0~2A	82%	83g	IP20	170*40*14
GWCV-2424	24W	AC170-265V	24V	0~1A	83%	83g	IP20	170*40*14



36W IP20 Indoor
Ultra-Thin Aluminium Power Supply
室内超薄铝壳电源

CE RoHS F V 20~30° 120 85° Tc 10~15° SELV

型号 Model No.	功率 Power	输入电压 Input Voltage	输出电压 Output Voltage	输出电流 Output Current	效率 Efficiency	重量 N.W	防护等级 IP	尺寸 Size(MM)
GWCV-3612	36W	AC170-265V	12V	0~3A	82%	93g	IP20	200*40*14
GWCV-3624	36W	AC170-265V	24V	0~1.5A	83%	93g	IP20	200*40*14

室内胶壳驱动电源

Indoor Plastic LED Power Supply

产品特点 Product Features

- ◆ 恒压设计 Constant voltage design
- ◆ 内设短路/过压过载/过热保护 Short circuit/overload/over temperature protect
- ◆ 100%满负载测试 100% full load burn-in test
- ◆ 空气自然对流散热 Air natural convection colling
- ◆ 符合IP20防护等级, RoHS环保标准 Comply with IP20&RoHS standards
- ◆ CE, RoHS认证 CE, RoHS Certificate

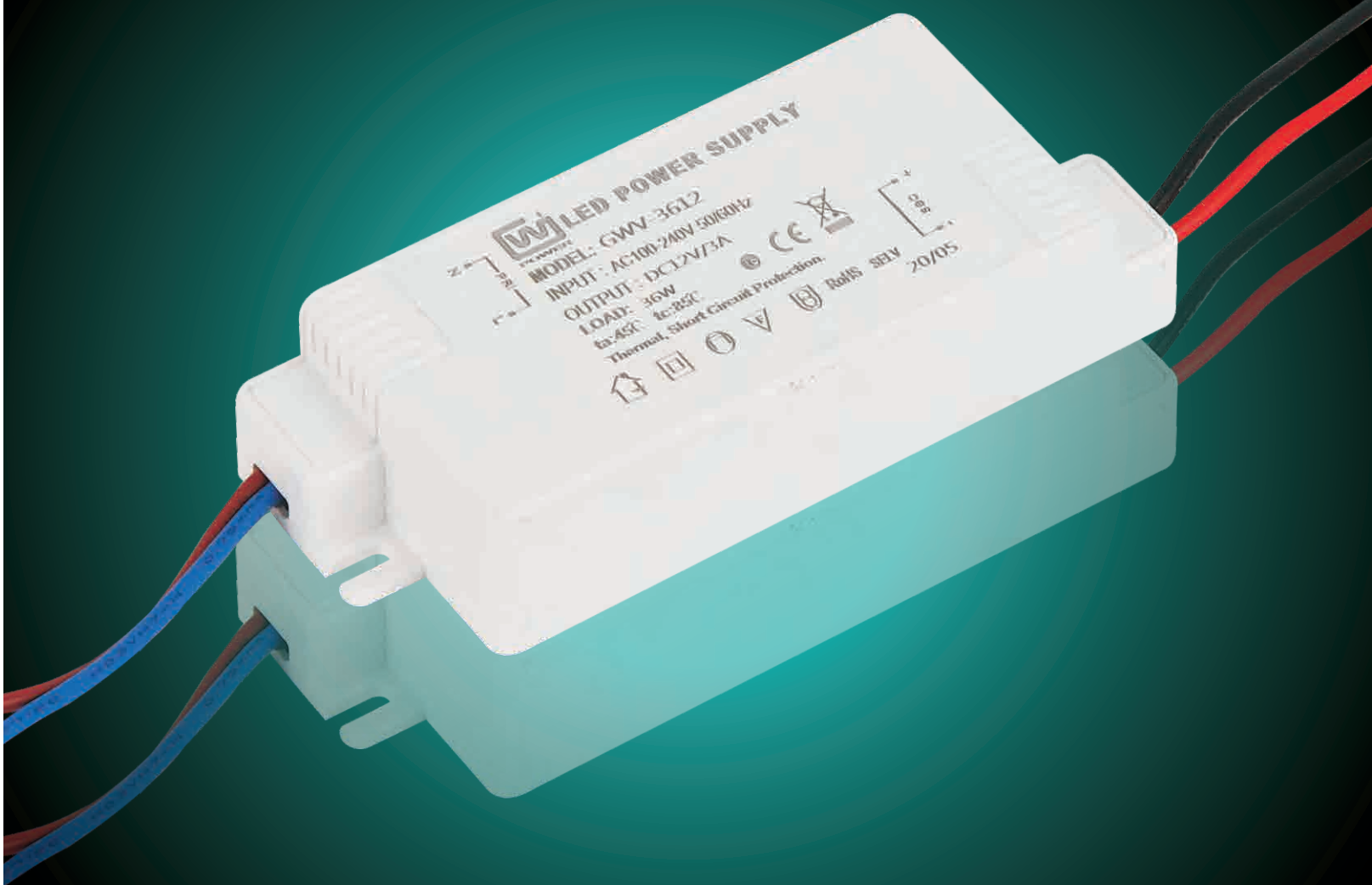



12W IP20 Indoor Plastic LED Power Supply
室内胶壳电源



型号 Model No.	功率 Power	输入电压 Input Voltage	输出电压 Output Voltage	输出电流 Output Current	效率 Efficiency	重量 N.W	防护等级 IP	尺寸 Size(MM)
GWV-1212	12W	AC100-240V	12V	0~1A	82%	47g	IP20	85*35*20
GWV-1224	12W	AC100-240V	24V	0~0.5A	83%	47g	IP20	85*35*20



24W IP20 Indoor Plastic LED Power Supply
室内胶壳电源



型号 Model No.	功率 Power	输入电压 Input Voltage	输出电压 Output Voltage	输出电流 Output Current	效率 Efficiency	重量 N.W	防护等级 IP	尺寸 Size(MM)
GWV-2412	24W	AC100-240V	12V	0~2A	82%	79g	IP20	95*45*20
GWV-2424	24W	AC100-240V	24V	0~1A	83%	79g	IP20	95*45*20



36W IP20 Indoor Plastic LED Power Supply
室内胶壳电源



型号 Model No.	功率 Power	输入电压 Input Voltage	输出电压 Output Voltage	输出电流 Output Current	效率 Efficiency	重量 N.W	防护等级 IP	尺寸 Size(MM)
GWV-3612	36W	AC100-240V	12V	0~3A	82%	85g	IP20	110*45*24
GWV-3624	36W	AC100-240V	24V	0~1.5A	83%	85g	IP20	110*45*24

内置继电器驱动电源

Indoor Built-in Relay LED Power Supply

产品特点 Product Features

- ◆ 恒压设计 Constant voltage design
- ◆ 内设短路/过压过载/过热保护 Short circuit/overload/over/temperature protect
- ◆ 100%满负载测试 100% full load burn-in test
- ◆ 内置继电器，安装便捷 Power supply built-in relay, easy installation





24W/36W Indoor built-in relay Power Supply Series 铝壳内置继电器电源系列

CE RoHS F B 20°+50° IP20 Tc 85° W W Ta -10°+45° SELV

型号 Model No.	功率 Power	输入电压 Input Voltage	输出电压 Output Voltage	输出电流 Output Current	效率 Efficiency	重量 N.W	防护等级 IP	尺寸 Size(MM)
GWCV-2412	24W	AC170-240V	12V	0~2A	82%	83g	IP20	170*40*14
GWCV-2424	24W	AC170-240V	24V	0~1A	83%	83g	IP20	170*40*14
GWCV-3612	36W	AC170-240V	12V	0~3A	82%	93g	IP20	200*40*14
GWCV-3624	36W	AC170-240V	24V	0~1.5A	83%	93g	IP20	200*40*14



24W/36W Indoor built-in relay Power Supply Series 胶壳内置继电器电源系列

CE RoHS F B 20°+50° IP20 Tc 85° W W Ta -10°+45° SELV

型号 Model No.	功率 Power	输入电压 Input Voltage	输出电压 Output Voltage	输出电流 Output Current	效率 Efficiency	重量 N.W	防护等级 IP	尺寸 Size(MM)
GWV-2412+GWP	24W	AC170-265V	12V	0~2A	82%	102g	IP20	90*45*14
GWV-3612+GWP	36W	AC170-265V	12V	0~3A	82%	108g	IP20	110*45*14

电子开关系列

Electronic Switch Series



产品特点 Product Features

- ◆ 工作电压范围宽,适用于直流12V/24V输出的任何电源
Wide working voltage range, fit to in any power supply of DC12V/24V output
- ◆ 触摸灵敏度高,抗干扰能力强 High touch sensitivity, High capacity of anti-interference
- ◆ LED灯调光器/防雾或除雾器功能控制分别以两种方式进行
LED light dimmer/anti-fog or demister function control separately in 2 ways
- ◆ 配支架,易于安装 Easy to assemble with bracket
- ◆ 适用于3-6mm玻璃介质的灯具 Suitable for 3-6mm glass medium
- ◆ 触摸点直径大小18-20mm Touch point diameter:18-20mm



输入/Input: DC12V
 输出/Output: DC12V 5A
 指示灯光/Indicator Light: White(ON),Blue(OFF)
 最大支持6M玻璃/ Support Mirror Thickness: Max 6MM
 电容式感应/Sensing Type: Capacitive Sensing
 触摸直径18-20MM/Touch Point Diameter:18-20MM
 功能: 短按--灯光ON/OFF
 Function: Short touch LED light ON/OFF



型号 Model No.	功率 Power	输入电压 Input Voltage	输出电压 Output Voltage	输出电流 Output Current	传感器模式 Sensor Mode	重量 N.W	防护等级 IP	尺寸 Size(MM)
GTS-1W	60W	DC12V	DC12V	5A	Capacitance Sensor	23.5g	IP20	65*67*12



输入/Input: DC12V
 输出/Output: DC12V 5A
 指示灯光/Indicator Light: White(ON),Blue(OFF)
 最大支持6M玻璃/ Support Mirror Thickness: Max 6MM
 电容式感应/Sensing Type: Capacitive Sensing
 触摸直径18-20MM/Touch Point Diameter:18-20MM
 功能: 短按灯光ON/OFF, 长按调节亮度 (10%-100%)
 Function:
 Short touch LED light ON/OFF
 Long-press /dimmer (brightness :10%-100%)



型号 Model No.	功率 Power	输入电压 Input Voltage	输出电压 Output Voltage	输出电流 Output Current	传感器模式 Sensor Mode	重量 N.W	防护等级 IP	尺寸 Size(MM)
GTS-1W1201	60W	DC12V	DC12V	5A	Capacitance Sensor	23.5g	IP20	65*67*12



输入/Input: DC12V
 输出/Output: DC12V 5A
 指示灯光/Indicator Light: White(ON),Blue(OFF)
 最大支持6M玻璃/ Support Mirror Thickness: Max 6MM
 电容式感应/Sensing Type: Capacitive Sensing
 触摸直径18-20MM/Touch Point Diameter:18-20MM
 功能: 短按--灯光ON/OFF, 长按调节亮度 (10%-100%) , 快速点击切换色温。
 Function:
 •Short touch LED light ON/OFF
 •Long-press /dimmer(brightness :10%-100%)
 •CCT by quick click



型号 Model No.	功率 Power	输入电压 Input Voltage	输出电压 Output Voltage	输出电流 Output Current	传感器模式 Sensor Mode	重量 N.W	防护等级 IP	尺寸 Size(MM)
GTS-1W1203	60W	DC12V	DC12V	5A	Capacitance Sensor	23.5g	IP20	65*67*12



型号/Model No:GTS-2W1201
 输入/Input: DC12V
 输出/Output: DC12V 5A
 指示灯光/Indicator Light: White(ON),Blue(OFF)
 最大支持6M玻璃/Support Mirror Thickness:Max 6MM
 电容式感应/Sensing Type:Capacitive Sensing
 触摸直径18-20MM/Touch Point Diameter:18-20MM
 功能:
 按键1: 短按---灯光ON/OFF,切换灯带色温, 长按调节亮度 (10% - 100%)
 按键2: 短按---除雾ON/OFF,支持防雾继电器控制
 注: GTS-2W (功能:开/关/调光/除雾)
 Function:
 Button 1:
 ▲ Short touch LED light ON/OFF
 ▲ CCT by quick click
 ▲ Long-press Dimmer (Brightness:10% - 100%)
 Button 2:
 ▲ Defogger ON/OFF,Support defogging relay control
 Remarks: GTS-2W (Function:On/Off/Dimmer/Defog Switch)

CE RoHS SELV

型号 Model No.	功率 Power	输入电压 Input Voltage	输出电压 Output Voltage	输出电流 Output Current	传感器模式 Sensor Mode	重量 N.W	防护等级 IP	尺寸 Size(MM)
GTS-2W	60W	DC12V	DC12V	5A	Capacitance Sensor	32g	IP20	70*75*10
GTS-2W1201	60W	DC12V	DC12V	5A	Capacitance Sensor	32g	IP20	70*75*10

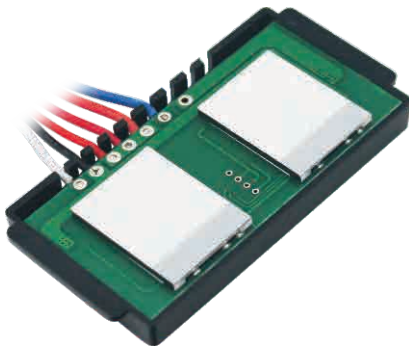

型号/Model No:GTS-2W1201-A
 输入/Input: DC12V
 输出/Output: DC12V 5A
 指示灯光/Indicator Light: White(ON),Blue(OFF)
 最大支持6M玻璃/Support Mirror Thickness:Max 6MM
 电容式感应/Sensing Type:Capacitive Sensing
 触摸直径18-20MM/Touch Point Diameter:18-20MM
 功能:
 按键1: 短按---灯光ON/OFF,切换灯带色温, 长按调节亮度 (10% - 100%)
 按键2: 短按---除雾ON/OFF,支持防雾继电器控制
 注: GTS-2W-A (功能:开/关/调光/除雾)
 Function:
 Button 1:
 ▲ Short touch LED light ON/OFF
 ▲ CCT by quick click
 ▲ Long-press Dimmer (Brightness:10% - 100%)
 Button 2:
 ▲ Defogger ON/OFF,Support defogging relay control
 Remarks: GTS-2W-A (Function:On/Off/Dimmer/Defog Switch)

CE RoHS SELV

型号 Model No.	功率 Power	输入电压 Input Voltage	输出电压 Output Voltage	输出电流 Output Current	传感器模式 Sensor Mode	重量 N.W	防护等级 IP	尺寸 Size(MM)
GTS-2W-A	60W	DC12V	DC12V	5A	Capacitance Sensor	40g	IP20	112*52*10
GTS-2W1201-A	60W	DC12V	DC12V	5A	Capacitance Sensor	40g	IP20	112*52*10

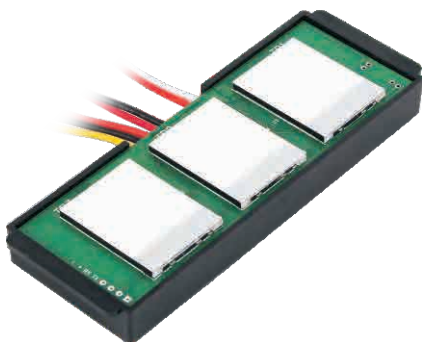

输入/Input: DC12V
 输出/Output: DC12V 5A
 指示灯光/Indicator Light: White(ON),Blue(OFF)
 最大支持6M玻璃/ Support Mirror Thinckness: Max 6MM
 电容式感应/Sensing Type: capacitive sensing
 触摸直径18-20MM/Toch Point Diameter:18-20MM
 功能:
 按键1: 短按---灯光ON/OFF, 长按调节亮度 (10%-100%) 。
 按键2: 短按---切换灯带色温
 按键3: 短按---除雾ON/OFF
 Function:
 Button 1:
 •Short touch LED light ON/OFF
 •Long-press/dimmer(brightness :10%-100%)
 Button 2:
 •CCT by quick click
 Button 3:
 •Defogger ON/OFF, Support defogging control

CE RoHS SELV

型号 Model No.	功率 Power	输入电压 Input Voltage	输出电压 Output Voltage	输出电流 Output Current	传感器模式 Sensor Mode	重量 N.W	防护等级 IP	尺寸 Size(MM)
GTS-3W1203	60W	DC12V	DC12V	5A	Capacitance Sensor	60g	IP20	130*78*12



输入/Input: DC12V
 输出/Output: DC12V 5A
 指示灯光/Indicator Light: White(ON),Blue(OFF)
 最大支持6M玻璃/ Support Mirror Thinckness: Max 6MM
 电容式感应/Sensing Type: capacitive sensing
 触摸直径18-20MM/Touch Point Diameter:18-20MM
 功能:
 按键1: 短按---灯光ON/OFF, 长按调节亮度 (10%-100%)。
 按键2: 短按--除雾ON/OFF, 继电器内置
 LED屏: 时间温度显示
 Function:
 Button 1:
 •Short touch LED light ON/OFF
 •Long-press/dimmer (brightness :10%-100%)
 Button 2:
 •Defogger ON/OFF (Relay built-in)
 LED Screen:
 •Time and Temperature Display



型号 Model No.	功率 Power	输入电压 Input Voltage	输出电压 Output Voltage	输出电流 Output Current	传感器模式 Sensor Mode	重量 N.W	防护等级 IP	尺寸 Size(MM)
GTS-2W1207	60W	DC12V	DC12V	5A	Capacitance Sensor	70g	IP20	119.5*73*10



输入/Input: DC12V
 输出/Output: DC12V 5A
 指示灯光/Indicator Light: White(ON),Blue(OFF)
 最大支持6M玻璃/ Support Mirror Thinckness: Max 6MM
 电容式感应/Sensing Type: capacitive sensing
 触摸直径18-20MM/Touch Point Diameter:18-20MM
 功能:
 按键1: 短按---灯光ON/OFF, 快速点击切换色温, 长按调节亮度 (10%-100%)。
 按键2: 短按--除雾ON/OFF, 继电器内置
 LED屏: 时间温度显示
 Function:
 Button 1:
 •Short touch LED light ON/OFF
 •CCT by quick click
 •Long-press /dimmer(brightness :10%-100%)
 Button 2:
 •Defogger ON/OFF (Relay built-in)
 LED Screen:
 •Time and Temperature Display



型号 Model No.	功率 Power	输入电压 Input Voltage	输出电压 Output Voltage	输出电流 Output Current	传感器模式 Sensor Mode	重量 N.W	防护等级 IP	尺寸 Size(MM)
GTS-2W1208	60W	DC12V	DC12V	5A	Capacitance Sensor	72g	IP20	119.5*73*10

型号/Model No.:GWP
 功能模式/Option Mode
 开关次数/Frequency:≥10万次 (阴性能负载) /100 Thousand times (resistive loads)
 产品特点/Product Features:
 控制信号电压/Control signal voltage :12/24V
 防水等级/Waterproof: IP20
 额定电压/Rated voltage :AC 100/240V
 最大电流/Output Current: 3000mA
 最大输出功率/Output Power: 300/720W
 重量/N.W:14.5g
 尺寸/Size: 38*23*20

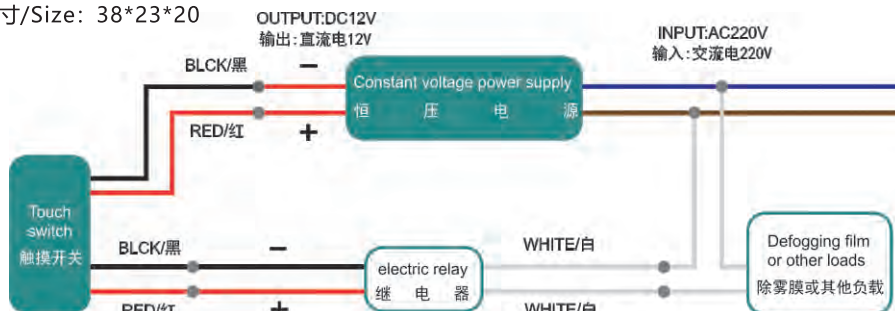
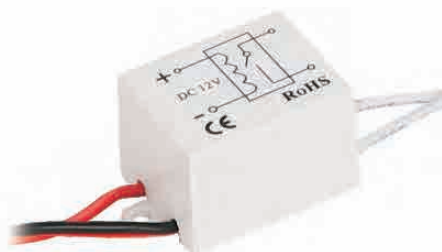

经济款超薄灯箱电源

Economical ultra-thin light box power supply

产品特点 Product Features

- ◆ 恒压设计 Constant voltage design
- ◆ 内设短路/过压过载/过热保护 Short circuit/overload/over temperature protect
- ◆ 100%满负载测试 100% full load burn-in test
- ◆ 空气自然对流散热 Air natural convection colling
- ◆ 符合IP20防护等级, RoHS环保标准 Comply with IP20&RoHS standards
- ◆ CE, RoHS认证 CE, RoHS Certificate





18W24W



型号 Model No.	功率 Power	输入电压 Input Voltage	输出电压 Output Voltage	输出电流 Output Current	效率 Efficiency	重量 N.W	防护等级 IP	尺寸 Size(MM)
TZ-1812CV-LB	18W	AC100-240V	12V	0~1.5A	83%	41g	IP20	172*18*18
TZ-2412CV-LB	24W	AC100-240V	12V	0~2A	83%	44g	IP20	172*18*18
TZ-2424CV-LB	24W	AC100-240V	24V	0~1A	83%	44g	IP20	172*18*18



36W48W



型号 Model No.	功率 Power	输入电压 Input Voltage	输出电压 Output Voltage	输出电流 Output Current	效率 Efficiency	重量 N.W	防护等级 IP	尺寸 Size(MM)
TZ-3612CV-LB	36W	AC100-240V	12V	0~3A	83%	68g	IP20	282*18*18
TZ-3624CV-LB	36W	AC100-240V	24V	0~1.5A	83%	68g	IP20	282*18*18
TZ-4812CV-LB	48W	AC100-240V	12V	0~4A	83%	77g	IP20	312*18*18
TZ-4824CV-LB	48W	AC100-240V	24V	0~2A	83%	77g	IP20	312*18*18



60W72W



型号 Model No.	功率 Power	输入电压 Input Voltage	输出电压 Output Voltage	输出电流 Output Current	效率 Efficiency	重量 N.W	防护等级 IP	尺寸 Size(MM)
TZ-6012CV-LB	60W	AC100-240V	12V	0~5A	83%	92g	IP20	312*18*18
TZ-6024CV-LB	60W	AC100-240V	24V	0~2.5A	83%	92g	IP20	312*18*18
TZ-7212CV-LB	72W	AC100-240V	12V	0~6A	83%	109g	IP20	375*18*18
TZ-7224CV-LB	72W	AC100-240V	24V	0~3A	83%	109g	IP20	375*18*18

智能镜防雾膜

Mirror Defogger



产品特点 Product Features

- ◆ **产品薄而轻，能保证强度，有利于传热和安装。**
The product is thin and light and can guarantee the strength, being beneficial to heat transfer and installation.
- ◆ **电压：根据不同客户需求配置不同电压。如：12V、24V、110V-130V、220V-240V等。**
Voltage: Mirror defogger produces different voltage according to the requirements in different countries. For example, 12V, 24V, 110V-130V, 220V-240V and so on.
- ◆ **产品认证：防雾膜通过：CE、ROHS等国际认证。**
Certification: Defogger has passed the international certifications, such as CE, ROHS.
- ◆ **造型多样：可定制长方形、正方形、圆形、等多种形状。**
Multiple models: Mirror defogger may be customized into rectangle, square, circle and other shapes.
- ◆ **使用期限：采用符合国际标准的优质原料，使用寿命在十年以上。**
Service life: Mirror defogger is made of high-quality materials complying with GB standard, to ensure that the service life is over ten years.



规格尺寸(mm) Size and specification(mm)	接线方式 Connection mode	电压可选 Voltage available for choice	认证标准 Certification standard
200X300	电线 Electric wire	12V、24、110-130V、220-240V	CE,RoHS,SAA,IP54
300X400	电线 Electric wire	12V、24、110-130V、220-240V	CE,RoHS,SAA,IP54
300X500	电线 Electric wire	12V、24、110-130V、220-240V	CE,RoHS,SAA,IP54
400X500	电线 Electric wire	12V、24、110-130V、220-240V	CE,RoHS,SAA,IP54
400X600	电线 Electric wire	12V、24、110-130V、220-240V	CE,RoHS,SAA,IP54
350X500	电线 Electric wire	12V、24、110-130V、220-240V	CE,RoHS,SAA,IP54
350X600	电线 Electric wire	12V、24、110-130V、220-240V	CE,RoHS,SAA,IP54
350X700	电线 Electric wire	12V、24、110-130V、220-240V	CE,RoHS,SAA,IP54
350X800	电线 Electric wire	12V、24、110-130V、220-240V	CE,RoHS,SAA,IP54
500X500	电线 Electric wire	12V、24、110-130V、220-240V	CE,RoHS,SAA,IP54



规格尺寸(mm) Size and specification(mm)	接线方式 Connection mode	电压可选 Voltage available for choice	认证标准 Certification standard
Dia 300	电线 Electric wire	12V、24、110-130V、220-240V	CE,RoHS,SAA,IP54
Dia 400	电线 Electric wire	12V、24、110-130V、220-240V	CE,RoHS,SAA,IP54
Dia 500	电线 Electric wire	12V、24、110-130V、220-240V	CE,RoHS,SAA,IP54
Dia 600	电线 Electric wire	12V、24、110-130V、220-240V	CE,RoHS,SAA,IP54

智能镜电器装饰盒

LED mirror Decoration box



产品特点 Product Features

- ◆ 经济耐用，抗冲击，耐腐蚀
Economic durability, Impact resistance, Corrosion resistance
- ◆ 防水，防尘，防触电
Waterproof, Dustproof, Anti-electric Shock
- ◆ 超薄设计，安装简单
Ultra-thin design, Easy to install



型号 Model No.	外形 Shape	规格尺寸 size	材料 Material
GWF-N04	Rectangle	230*150*20mm	ABS
GWF-N06	Rectangle	230*150*25mm	ABS
GWF-N08	Rectangle	210*160*20mm	ABS
GWF-N09	Rectangle	250*80*20mm	ABS



型号 Model No.	外形 Shape	规格尺寸 size	材料 Material
GWF-N10	camber	230*150*20mm	ABS
GWF-N11	camber	200*150*20mm	ABS
GWF-N12	camber	200*150*25mm	ABS

12V/24V灯带

12V/24V LED Strip

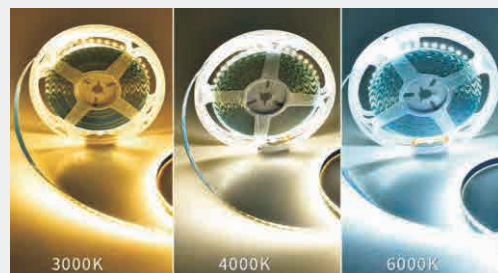
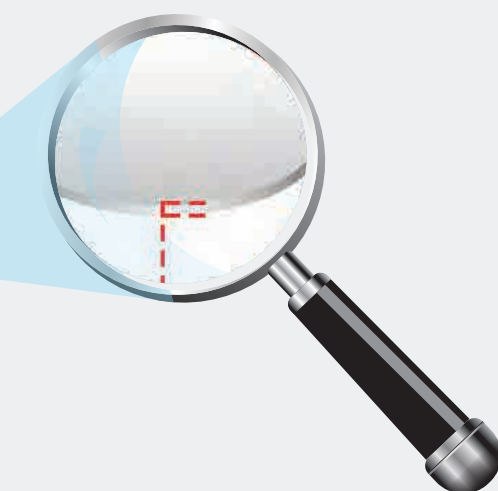

产品特点 Product Features

- ◆ 采用高亮度2835灯珠，亮度更高光效更加均匀
Using high-brightness 2835 lamp beads, the brightness is higher and the light efficiency is more uniform
- ◆ 双面板灯板，散热快，低光衰，寿命长
Double panel PCB, Fast heat dissipation, low light decay, longer life
- ◆ 采用精密电阻，稳定输出大功率电流，提供明亮发光二极管
with precision resistors, Stable output of high power current, providing bright led
- ◆ 自带背胶，安装方便
Equipped with double-sided adhesive tape, easy to install
- ◆ IP20,IP65,IP67,IP68多种防水等级可选
IP20, IP65, IP67, IP68 various waterproof rate are optional

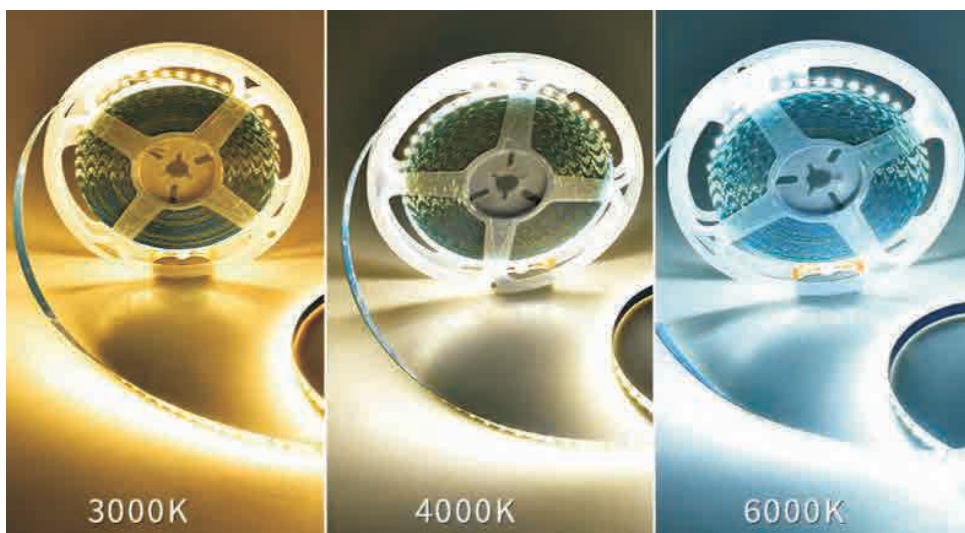

型号 Model No.	功率 Power	输入电压 Input Voltage	输出电压 Output Voltage	板宽 PCB Width	灯数 LED Qty	颜色 Color	显指 CRI	重量 N.W. (g)	防护等级 IP	尺寸 Size(MM)
GW-2835 1203K	9W/M	AC220V	DC12V/DC24V	8mm	120LEDs/m	3000K	80Ra	80g	IP20	5000x10mm
GW-2835 1204K	9W/M	AC220V	DC12V/DC24V	8mm	120LEDs/m	4000K	80Ra	80g	IP20	5000x10mm
GW-2835 1206K	9W/M	AC220V	DC12V/DC24V	8mm	120LEDs/m	6000K	80Ra	80g	IP20	5000x10mm



型号 Model No.	功率 Power	输入电压 Input Voltage	输出电压 Output Voltage	板宽 PCB Width	灯数 LED Qty	颜色 Color	显指 CRI	重量 N.W. (g)	防护等级 IP	尺寸 Size(MM)
GW-2835 1203K6K	9W/M	AC220V	DC12V/DC24V	8mm	120LEDs/m	CCT (3000K-6000K)	80Ra	80g	IP20	5000x10mm

- ▶ 请不要改造、分解或取下电源外壳。如有需要请及时与我司客服联系。请勿在电源通电时触摸产品上的电子元器件，否则会有触电或更伤的危险。
- ▶ 连接电源输入或输出时，请切断电源。
- ▶ 请在通电前检查输入、输出线是否连接正确；确保输入、输出没有短路、接反；同时请确认输入电压是否与产品标称值一致。
- ▶ 为了保证安全和较小的电磁干扰，请确保产品接地端被可靠接地。接地导线通常要求18AWG或以上的线径。
- ▶ 在强雷击地区或防雷措施不规范的建筑野外使用本产品时，请在输入侧安装防雷设备。
- ▶ 电源的使用环境温度也非常重要，电源内部的温升直接与它周围温度有关，需要增加额外的辅助散热装置，如果在过高的使用环境温度下必须降额使用输出功率，这样科学使用电源可以延长电源使用寿命和降低您的维护费用，（使用时，请参考温度降额曲线，参见附图）。

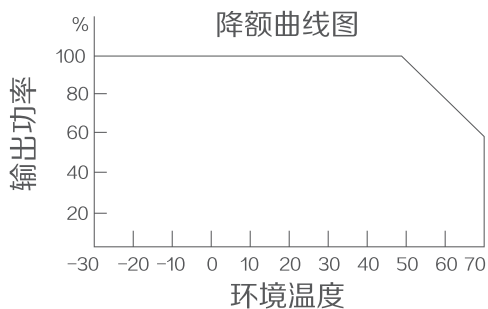

- ▶ 安装使用供电建议：一次性启动总功率不要太大，每相电一般不大于10KW负载功率，具体还要与变压器能承受的负荷相匹配，三相电要平衡,分批延时启动。防止大功率启动时交流冲击波过大导致电网不稳定。
- ▶ 如供电系统对接入电网的设备有功率因数要求的，需选择带PFC功能的电源产品，以减少对其他设备的干扰，可以减少相线与零线电流，零线电流减少特别明显。输入变压器功率有限额要求的，在不增大输入变压器功率的基础上，可选择带PFC功能的产品，以提高变压器的待载能力。
- ▶ 在低温环境下，必须选用低温电源，常规电源的最低工作温度为-30℃，低于-30℃时，需选用低温电源，低温电源-40℃。

使用注意事项 Precautions For Use



- ▶ Do not transform, decompose or remove the power enclosure. Please contact our customer service if necessary. Do not touch the electronic components of the product when the power is energized, otherwise there will be electric shock or more damage.
- ▶ Connect the power input or output to remove the power supply.
- ▶ Check whether the input and output lines are connected correctly before the power is connected. Ensure input and output does not have short circuit and reverse; it is also clear whether the input voltage is consistent with the product nominal value.
- ▶ To ensure safety and small electromagnetic interference, make sure the grounding end of the product is reliably grounded. Ground conductors usually require a line diameter of 18AWG or above.
- ▶ Please install lightning protection equipment on the input side when using this product in the non-standard construction field of strong lightning strike area or lightning protection.
- ▶ Power using the environment temperature is also very important, the internal temperature rise is directly related to the temperature around it, need to add additional auxiliary cooling device, if used in high ambient temperature must be used derating power output, this scientific use of the power supply can prolong the service life of the power supply and reduce your maintenance costs, (derating use, please refer to the temperature curve, see chart).

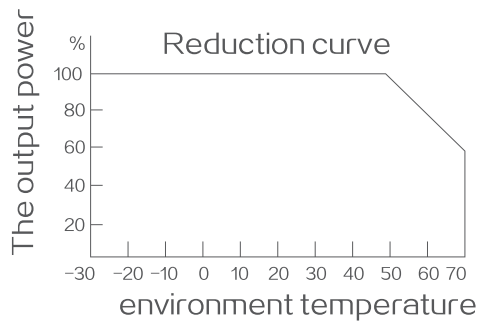

- ▶ Install and use power supply advice: one-time start the total power does not want too big, each phase are rarely more than 10 kw electric load power, specific to match the transformer can bear the load, three-phase electric balance, partial delay start. It is not stable to exchange shock wave when high power start
- ▶ Such as power supply system of grid equipment with power factor requirements, need to choose power source with PFC function product, in order to reduce the interference to other equipment, can reduce phase line and zero line current, the zero line current reduce particularly evident. The input transformer power has the requirement, on the basis of not increasing the power of input transformer, the product with PFC function can be selected to improve the waiting capacity of the transformer..
- ▶ In low temperature environment, must choose low power, the lowest working temperature of conventional power is -30°C , below -30°C , need power at low temperature, low temperature power -40°C .

国际阿里 : <https://zhguangwei.en.alibaba.com>

国内阿里 : <https://gwleddriver.1688.com>

珠海光唯电子有限公司

ZHUHAI GUANGWELL ELECTRONICS CO.,LTD

中山市拓智科技有限公司

ZHONGSHAN TUOZHI TECHNOLOGY CO.,LTD

办公地址: 珠海市横琴新区宝华路6号105室-17304

Office Address: Room 105-17304, No.6 Baohua Road, Hengqin New District, Zhuhai City, Guangdong Province, China

工厂地址: 广东省中山市三乡镇新圩村兴业西路2号 二楼和四楼

Factory Address: Floor 2 and 4, No.2 Xingye West Road, Xinu Village, Sanxiang Town, Zhongshan City, Guangdong Province, China

TEL: 0086-760-86331166

FAX: 0086-760-86331133

Email: info@zhgwpower.com

WWW.ZHGWPOWER.COM



alibaba.com



1688.com